

# Hydrogen Atoms as Convenient Synthetic Reagents: Mercury-Photosensitized Dimerization of Functionalized Organic Compounds in the Presence of H<sub>2</sub>

Cesar A. Muedas, Richard R. Ferguson, Stephen H. Brown, and Robert H. Crabtree\*

Contribution from the Sterling Chemistry Laboratory, Yale University,  
225 Prospect Street, New Haven, Connecticut 06520. Received August 13, 1990

**Abstract:** Hydrogen atoms are generated by mercury photosensitization in an unexceptional apparatus that makes them readily available for organic chemistry on a preparatively useful scale at 1 atm of pressure and temperatures from 0–150 °C. The H atoms add to CH<sub>2</sub>=CH—CH<sub>2</sub>X to give the intermediate radical CH<sub>2</sub>—(•CH)—CH<sub>2</sub>X, which dimerizes to give CH<sub>2</sub>CH(CH<sub>2</sub>X)—CH(CH<sub>2</sub>X)CH<sub>2</sub>. The saturated substrates CH<sub>3</sub>CH<sub>2</sub>CH<sub>2</sub>X undergo H abstraction to give CH<sub>3</sub>CH<sub>2</sub>(•CH)X as intermediates and CH<sub>3</sub>CH<sub>2</sub>CH(X)—CH(X)CH<sub>2</sub>CH<sub>3</sub> as final products. The reaction shows a tolerance for different functional groups, X, which may be an alkyl or fluoroalkyl chain or contain vinyl, epoxy, ester, ketone, nitrile, and silyl groups. Radical disproportionation products are also formed but are easily separated. H atoms attack the weakest C—H bonds of the substrates with high selectivity. In our earliest direct mercury photosensitization, Hg\* often failed to attack the substrate C—H bonds to give dimers; the presence of H<sub>2</sub> strongly suppresses direct Hg\* chemistry. H atoms are not sensitive to steric or polar effects. Radical fragmentation is avoided by using “high” pressures (1 atm). Intramolecular radical additions to C=C bonds and methyl group 1,2-shift were also seen in some cases. Exceptional product ratios are observed for cross-reactions involving hydroxyalkyl radicals where H-bonding favors the homodimers in certain cases. Several bond strengths of C—H bonds α to CO were determined: EtCO<sub>2</sub>Me, 94.5; *i*-PrCO<sub>2</sub>Me, 92.7; cyclopentanone, 94.3; (*i*-Pr)<sub>2</sub>CO, 91.9 kcal/mol.

## Introduction

Hydrogen atoms have not previously been widely available in synthesis for lack of a convenient way of producing and using them. In this paper, we show how they can be made at ambient temperature and pressure with use of unexceptional laboratory apparatus in a way that allows us to make a variety of organic compounds on a multigram scale. The method is a development of our prior application of mercury photosensitization<sup>1a,b</sup> to dehydrodimerization on a preparative scale.<sup>1c–g</sup> Equations 1–5

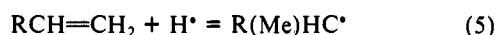
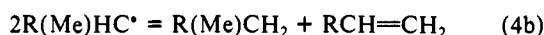
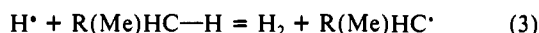
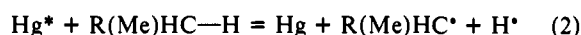

summarize the main reaction steps in this earlier work. Light (254 nm) from a low-pressure Hg lamp excites the Hg atoms (5d<sup>10</sup>6s<sup>2</sup>) in the reactor to the <sup>3</sup>P<sub>1</sub> state, Hg\*(5d<sup>10</sup>6s<sup>1</sup>6p<sup>1</sup>), 112 kcal/mol above the ground state (eq 1). Hg\* homolyzes a C—H bond in the substrate to give an H atom and a carbon-centered radical (eq 2). In the gas phase, no “third body” is available to remove the recombination energy,<sup>1a</sup> and so the H atoms tend not to recombine but instead abstract H from the substrate (eq 3). The radicals then recombine to give dimer (eq 4a) or disproportionate to give alkane and alkene (eq 4b).

Two points are important. First, some of the carbon radicals are formed by attack of an H atom on the substrate (eq 3). Second, the alkene formed in the disproportionation does not build up as a product because H atoms add to the alkene to give back the carbon-centered radical (eq 5). This suggested that H atoms might be preparatively useful if we could generate them under mild conditions in useful amounts. They might then either abstract from saturated substrates or add to unsaturated substrates. This

paper reports the results of our studies of hydrodimerization (eq 6) and dehydrodimerization (eq 7) via H atoms formed by Hg-photosensitized reaction of H<sub>2</sub>.

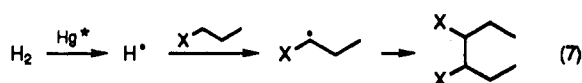
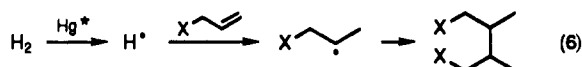

Our earlier Hg\* method<sup>1</sup> is restricted to substrates such as alkanes, alcohols, ethers, silanes, and some amines. For substrates with double bonds, Hg\* acts as a triplet sensitizer<sup>2</sup> and not as an H atom abstractor.

The weakest bonds in the substrate, such as C—C bonds in alkanes, are not cleaved, so the energy of the Hg\* is not simply transferred to the substrate molecule as a whole. It is the formation of an exciplex of the type (R<sub>3</sub>CHHg)\*<sup>3,4a</sup> that allows the energy of the excited atom to be delivered selectively to one C—H bond in eq 2. On the other hand, for a substrate with double bonds, the Hg\* probably binds to the double bonds or associated heteroatom lone pairs<sup>4a</sup> leading to a triplet sensitization, not H atom abstraction, and so dimers are not formed.

A recent study by Soep et al.<sup>3</sup> proposes a T-shaped structure for the exciplex between Hg\* and H<sub>2</sub>, Hg(η<sup>2</sup>-H<sub>2</sub>), reminiscent of a transition-metal dihydrogen complex.<sup>5</sup> The singly occupied p orbital of Hg\* is believed to play the role of back-bonding to H<sub>2</sub>(σ\*) just as do the metal (d<sub>π</sub>) electrons in the transition-metal analogues (Figure 1). This may account for the high efficiency of H atom formation from the Hg\* + H<sub>2</sub> reaction.

(2) Several examples of Hg\* as triplet sensitizer have been reported, see: (a) Inoue, Y.; Takamuku, S.; Sakurai, H. *Can. J. Chem.* **1976**, *54*, 3117. (b) Yamazaki, H.; Shida, S. *J. Chem. Phys.* **1956**, *24*, 1278. (c) Srinivasan, R. *J. Am. Chem. Soc.* **1961**, *83*, 4923. (d) Klunder, E. B.; Carr, R. W. *Ibid.* **1973**, *95*, 7386. (e) Hikuni, M.; Takase, A.; Murano, M.; Takahashi, M. *Bull. Chem. Soc. Jpn.* **1973**, *46*, 1048 and references cited.

(3) Breckenridge, W. H.; Jouvet, C.; Soep, B. *J. Chem. Phys.* **1986**, *84*, 1443.

(4) (a) Gunning, H. E.; Campbell, J. M.; Sandhu, H. S.; Strausz, O. P. *J. Am. Chem. Soc.* **1973**, *95*, 746. (b) Gunning, H. E.; Strausz, O. P. *Adv. Photochem.* **1963**, *1*, 209.

(5) (a) Kubas, G. J.; Swanson, B. I.; Vergamini, P. J.; Wasserman, H. J. *J. Am. Chem. Soc.* **1984**, *106*, 451. (b) Morris, R. H.; Sawyer, J. F.; Shiralia, M.; Zubkowski, J. D. *J. Am. Chem. Soc.* **1985**, *107*, 5581. (c) Crabtree, R. H.; Lavin, M.; Bonneviot, L. *Ibid.* **1986**, *108*, 4032. (d) Chinn, M.; Heinekey, D. M. *Ibid.* **1987**, *109*, 5865. (e) Hamilton, D. G.; Crabtree, R. H. *Ibid.* **1988**, *110*, 412.

(1) (a) Cvetanovic, R. J. *Prog. React. Kinet.* **1963**, *2*, 39. (b) Calvert, J. G.; Pitts, J. N. *Photochemistry*; Wiley: New York, 1966; pp 60–116. (c) Brown, S. H.; Crabtree, R. H. *J. Chem. Soc., Chem. Commun.* **1987**, 970. (d) Brown, S. H.; Crabtree, R. H. *Tetrahedron Lett.* **1987**, *28*, 5599. (e) Brown, S. H.; Crabtree, R. H. *J. Chem. Educ.* **1988**, *65*, 290. (f) Brown, S. H.; Crabtree, R. U. U.S. Patent 3,725,342. (g) Brown, S. H.; Crabtree, R. H. *J. Am. Chem. Soc.* **1989**, *111*, 2935, 2946.

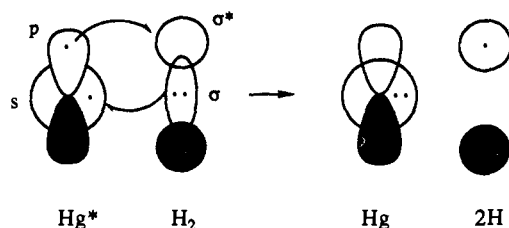

**Figure 1.** Electronic structure of the  $\text{Hg}(\text{H}_2)$  exciplex and its breakdown into H atoms.

Franck<sup>6</sup> was the first to show that  $\text{Hg}^*$  reacts with  $\text{H}_2$  to produce H atoms. Olson<sup>7a</sup> and Taylor<sup>7b-c</sup> studied the reaction of these H atoms with simple olefins. Few organic substrates of any complexity or with functional groups were examined. These authors only worked at low pressures, and the reaction did not always stop at the dimer stage but sometimes gave significant quantities of trimers and tetramers. In addition, a substantial proportion of the radicals sometimes fragmented to give other products. This is probably because these radicals are formed with ca. 40 kcal/mol of excess thermal energy that comes from the exothermicity of the  $[\text{H}^\bullet + \text{alkene}]$  reaction.<sup>8</sup> At low pressures, this excess energy tends not to be efficiently quenched by collisions, and especially for small substrates, radical decomposition is a significant pathway. Published studies in this general area have tended to be heavily physicochemical, focusing on the kinetics and mechanism of the formation and fragmentation of the radicals.<sup>9</sup>

As an alternative to Hg photosensitization, H atoms have previously been obtained by  $\gamma$ -irradiation of aqueous solutions, by direct photolysis of water at 185 nm, or in a low-pressure discharge.<sup>10</sup> In one of the rare cases in which the nature of the organic product was investigated, succinic acid was shown to be formed from acetic acid by  $\gamma$ -irradiation.<sup>11</sup> The generality of the method seemed to be very limited; although ethanol was shown to give butane-2,3-diol, 2-propanol gave only acetone and not the dimer, pinacol.<sup>12</sup> Mazur et al.<sup>13</sup> have shown how H atoms formed in a microwave discharge can be used to obtain hydrodimerization products from alkenes, but low pressures (2 Torr) had to be used. In none of the other methods of making H atoms is the experimental setup as convenient as the system described here, which uses only commonly available laboratory equipment at ambient temperature and pressure.

### Our Approach

To extend Hg-photosensitized dimerization to more complex substrates, we adapted our previous apparatus to allow generation of H atoms from homolysis of  $\text{H}_2$  by  $\text{Hg}^*$ . The H atoms should not form exciplexes with the substrate even when this contains multiple bonds but might either (a) simply abstract H atoms from the substrate or (b) add to the double bonds. In either case, a C-centered radical is formed.

For the H atom system to be preparatively useful, the problems of radical fragmentation needed to be solved.<sup>7-9</sup> Fragmentation is most severe at low pressures ( $p_{\text{tot}} < 20$  Torr) and for light hydrocarbons. In contrast, we always work at atmospheric

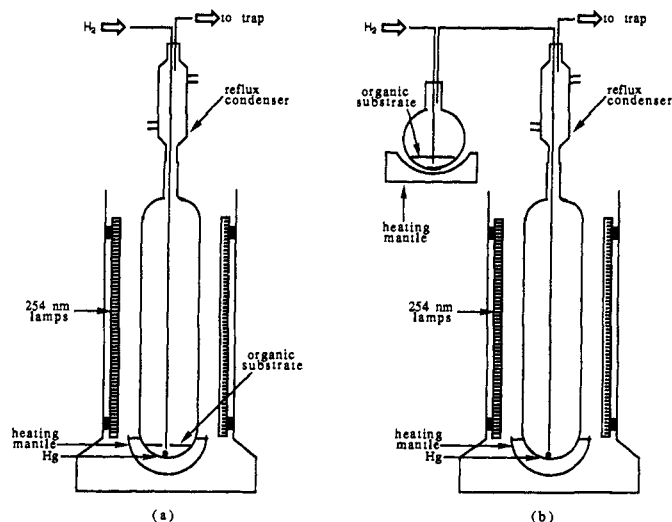

**Figure 2.** Diagram of apparatus for H atom reactions: (a) "in situ" technique, (b) "presaturation" technique.

pressure, where collisions with other species in the gas phase should tend to carry away the excess energy and stabilize the radicals. We also have a relatively high partial pressure of substrate, which should be more efficient than  $\text{H}_2$  at collisionally deactivating hot radicals. Prior studies were carried out on simple alkenes that have fewer degrees of freedom to absorb the excess energy than do the more complex molecules we have studied. It was therefore unclear what would happen under our conditions, but we find that fragmentation is a very minor pathway.

Extensive oligomerization of the substrate, of the sort found in prior studies,<sup>14</sup> would be a severe limitation on the preparative usefulness of the method. We have successfully attacked this problem by using vapor-pressure selectivity and by a judicious choice of  $\text{H}_2$ /substrate ratio.

A third potential problem is that  $\text{Hg}^*$  might competitively attack both  $\text{H}_2$  and the substrates, giving rise to an undesired mixture of dehydrodimers, triplet-sensitized products, and cross-products. This problem has been solved by using an excess of  $\text{H}_2$  over substrate so that  $\text{Hg}^*$  tends to react with  $\text{H}_2$  only. Surprisingly, we find that a modest excess of  $\text{H}_2$  is sufficient for this purpose.

Some of the purely preparative results described here have appeared in note form.<sup>15</sup>

**The Reactor.** The two versions of the apparatus used in H atom reactions are simple modifications of the one employed in  $\text{Hg}^*$  reactions.<sup>1b-g</sup> In one case (Figure 2a), the liquid substrate is placed at the bottom of the quartz reactor vessel and hydrogen is bubbled through the liquid by means of a long needle inserted from the top of the tube. In this "in situ" technique, the liquid substrate is present in the reaction vessel. In the other "presaturation" setup (Figure 2b), the substrate is placed in a separate flask. Hydrogen is bubbled through it, and once saturated with substrate vapor, the hydrogen is then passed into the bottom of the reactor, again by means of a long needle inserted from the top.

**Vapor Pressure Selectivity.** The concept of vapor pressure selectivity, extensively used in our previous work,<sup>1c-g</sup> helped solve the problem of oligomerization. When we dimerize an organic compound, the product is much less volatile than the starting material and returns to the liquid phase where it is protected from further reaction. This happens because mercury photosensitization only occurs in the vapor phase; the liquid phase is at least  $10^3$  less reactive. The reason may be that severe solvent broadening of the absorption lines of dissolved Hg leads to poor matching with a sharp 254-nm emission line of the low-pressure Hg lamp and

- (6) Cario, G.; Frank, J. Z. *Physik* **1922**, *11*, 155.  
 (7) (a) Olson, A. R.; Meyers, C. H. *J. Am. Chem. Soc.* **1926**, *48*, 389. (b) Taylor, H. S.; Marshall, A. L. *J. Phys. Chem.* **1925**, *29*, 1140. (c) Taylor, H. S.; Hill, D. G. *J. Am. Chem. Soc.* **1929**, *51*, 2922. (d) Junger, J. C.; Taylor, H. S. *J. Chem. Phys.* **1938**, *6*, 325. (e) Moore, W. J.; Taylor, H. S. *Ibid.* **1940**, *8*, 504.  
 (8) Rabinowitch, B. S.; Davis, S. G.; Winkler, C. A. *Can. J. Res.* **1943**, *B21*, 251.  
 (9) (a) Steacie, E. W. R. *Atom and Free Radical Reactions*, 2nd ed.; Reinhold: New York, 1954; pp 411-448, 506-521. (b) Cvetanovic, R. J. *Adv. Photochem.* **1963**, *1*, 114. (c) Rabinowitch, B. S.; Setser, D. W. *Ibid.* **1964**, *3*, 1. (d) Jones, W. E.; Macknight, S. D.; Teng, L. *Chem. Rev.* **1973**, *73*, 407. (e) Gibian, M. J.; Corley, R. C. *Ibid.* **1973**, *73*, 441.  
 (10) Neta, P. *Chem. Rev.* **1972**, *72*, 533.  
 (11) Garrison, W. M.; Bennett, W.; Cole, S.; Haymond, H. R.; Weeks, B. M. *J. Am. Chem. Soc.* **1955**, *77*, 2720.  
 (12) (a) Lifschitz, C.; Stein, G. *J. Chem. Soc.* **1962**, 3706. (b) Jayson, G. G.; Scholes, G.; Weiss, J. *Ibid.* **1957**, 1358.  
 (13) Beerl, A.; Berman, E.; Vishkausan, R.; Mazur, Y. *J. Am. Chem. Soc.* **1986**, *108*, 6413.

- (14) LeRoy, D. J.; Steacie, E. W. R. *J. Chem. Phys.* **1941**, *9*, 829.  
 (15) (a) Muedas, C. A.; Ferguson, R. R.; Crabtree, R. H. *Tetrahedron Lett.* **1989**, *30*, 3389. (b) Boojamra, C. G.; Crabtree, R. H.; Ferguson, R. R.; Muedas, C. A. *Tetrahedron Lett.* **1989**, *30*, 5583. (c) Muedas, C. A.; Ferguson, R. R.; Brown, S. H.; Crabtree, R. H., U.S. Patent 4,878,488.

**Table I.** Hydrodimerization of Alkenes vs Dehydrodimerization of Alkanes

substrate	conditions	dimer distribution (%)						
		2-2'	2-3'	2-4'	3-3'	3-4'	4-4'	1-n' <sup>a</sup>
1-pentene	Hg*, H <sub>2</sub>	73	4		3			20
<i>n</i> -pentane	Hg*	38	46		12			4
1-hexene	Hg*, H <sub>2</sub>	74	12		3			11
<i>n</i> -hexane	Hg*	23	45		21			11
1-octene	Hg*, H <sub>2</sub>	60	13	8	2	4	2	11
<i>n</i> -octane	Hg*	12	22	10	23	21	10	2

<sup>a</sup>Mixture of 1°-1° and 1°-2° dimers; the former as trace in every case (see text).

therefore to poor light absorption. Under our conditions, once the dimer has condensed, it is protected from further reaction, even at high conversion. This is very fortunate because the dimer is often inherently more reactive than the substrate. Although H atoms should retain their reactivity in the liquid phase, in practice, we observe very good selectivity and little secondary reaction. By this combination of chemical engineering with chemistry, we achieve a selectivity not possible by chemical methods alone.

**Selectivity Patterns in H Atom Addition to Alkenes.** An H atom tends to add to a C=C bond at the least substituted position to give the most stable radical.<sup>16</sup> Table I compares results from H atom reactions of alkenes with direct Hg\* photosensitization of alkanes. In every case, the selectivity for formation of dimers is dictated by the position of the unsaturation in the 1-alkenes. For example, from 1-hexene, we get only 10.75% of the 1°-2° and 0.24% 1°-1° products (i.e., dimers from a 1° and a 2° radical or from two 1° radicals, respectively<sup>17</sup>). This means that the major product is derived from the most stable 2° radicals. The selectivity of our new system for this reaction is therefore substantially greater than for Hg\* reactions of the corresponding alkanes. In previous work,<sup>16d</sup> the structures of the hydrodimers were not determined.

There are two reasonable routes to the 1°-2° products: (i) nonterminal addition of H atoms to give the 1° radical directly, followed by recombination with the more abundant 2° radicals (eq 8a), or (ii) terminal H\* addition to give the 2° radical, which in turn adds to the terminal position of 1-hexene, followed by disproportionation or H atom addition to the resulting radical (eq 8b). If eq 8a were the major pathway, then 0.1075/2 or 5.4%

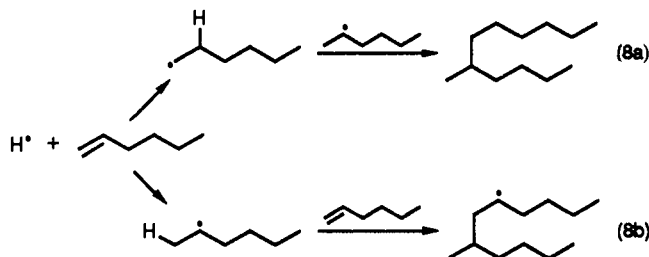

of the radicals formed should be primary. If this were so, then (0.054)<sup>2</sup> or 0.29% of the 1°-1° dimer, *n*-dodecane, should also be present. We see 0.24% of *n*-dodecane in the mixture, which implies that route i (eq 8a) is the major pathway to form the 1°-2° dimer but that some R\* addition to 1-hexene may also occur.

Product ratios from direct Hg\*-alkane dehydrodimerizations do not change with time.<sup>10-8</sup> In contrast, Table II shows how the initially high selectivity for 5,6-dimethyldecane degrades significantly in 1-hexene/H\* reactions. The initial proportion of 80% of 2,2'-dimer falls to 74% after 18 h. At first, the substrate is pure 1-hexene, but with time the disproportionation products, hexane and isomeric hexenes, are formed. These are mostly

(16) (a) Tardy, D. C.; Ravinovich, B. S.; Larson, C. W. *J. Chem. Phys.* **1966**, *45*, 1163. (b) Kurylo, M. J.; Peterson, N. C.; Braun, W. *Ibid.* **1971**, *54*, 4662. (c) Falconer, W. E.; Sunder, W. A. *Int. J. Chem. Kinet.* **1971**, *3*, 395. (d) Baulch, D. L.; Chown, P. K.; Montague, D. C. *Ibid.* **1979**, *11*, 1055.

(17) In Tables I and II, both 1°-1° and 1°-2° isomers are reported together as 1,n', i.e., dimers from recombination of radicals at C1 and Cn' in the starting monomer.

**Table II.** Hydrodimerization of Isomeric Hexenes<sup>a</sup>

substrate	reaction time (h)	dimer distribution (%)				
		2-2'	2-3'	3-3'	1-n' <sup>b</sup>	unsat <sup>c</sup>
1-hexene	0.5	80	3	2	15	
1-hexene	18	74	12	3	11	tr
2-hexene	0.5	21	45	30	2	2
2-hexene	18	22	48	22	2	4
3-hexene	0.5	2	12	81	tr	5
3-hexene	18	tr	2	92		6

<sup>a</sup>Conditions: Hg\*, H<sub>2</sub>. <sup>b</sup>Mixture of 1°-1° and 1°-2° dimers; the former as trace in every case (see text). <sup>c</sup>Unsaturated product from allylic abstraction.

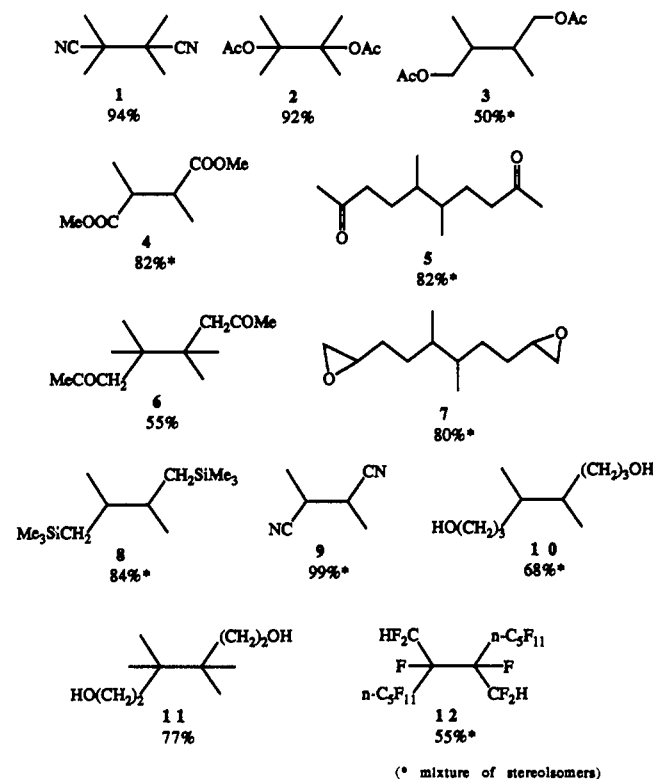
**Figure 3.** Some hydrodimerization products.

flushed out of the system by the gas flow (presaturation conditions), but they do eventually build up to some extent in the condensate. Once this has happened, these disproportionation products can participate in the reaction. After 18 h, ca. 10% of the dimers come from secondary reactions. The expected alkane and alkene disproportionation products can be isolated by passing the exit gases through a trap cooled to -80 °C.

Abstraction at an allylic position is known to be a minor process in the reaction of H atoms with alkenes (0.2% relative to H addition for propene, 1.6% for 1-butene).<sup>18</sup> Traces (<0.3%) of the resulting unsaturated dimers could be detected in H atom reactions of terminal monoolefins, but internal alkenes such as 2- and 3-hexene gave slightly more (Table II).

**Tolerance of Functional Groups.** A wide variety of functional groups are tolerated in the reaction. Figure 3 shows some of the hydrodimers synthesized. Esters, ketones, and nitriles with C=C bonds react smoothly, especially when the radical formed is 3° or α to a stabilizing group, such as -CN, or to a heteroatom. Direct Hg\* reactions with the saturated analogues of these substrates fail to give the dehydrodimer. Unsaturated ethers and silanes behave well, as is also true for the Hg\* reaction of their saturated counterparts. Epoxides are extremely sensitive to Hg\* attack and lead to undesired products by C—O bond breaking. We were very surprised to see that the bisepoxide **7** is formed in excellent yield from the unsaturated monoepoxide. The resulting

(18) Falconer, W. E.; Sunder, W. A. *Int. J. Chem. Kinet.* **1972**, *4*, 315.

Table III. Competitive Pathways in the Reaction of 1,5-Hexadiene

$p_v(\text{C}_6\text{H}_{10})$ (mmHg)	$\text{C}_6\text{H}_{10}/\text{H}_2$ (mol/mol)	Hg* route (i + ii) (%)	H atom route (iii + 2iv) (%)
418	1.22	28	72
244	0.47	19	81
68	0.10	7	93
22	0.03	2	98

bisepoxide may be useful as cross-linking agent for polymers.

Perfluoroolefins are especially interesting because the organic chemistry of fluorocarbons is less well-established than that of their perproto analogues, and the dimers formed in the reaction are not available by any other route. The H atoms add at what were the terminal positions of the C=C double bonds and are clearly identified in the  $^1\text{H}$  NMR. Their presence confirms the route suggested for the formation of the dimer via terminal H addition to the alkene. The dimer may be of interest as a specialty wax.

**Efficiency in the Generation of H Atoms.** We tested the partitioning between Hg\* and H atom chemistry using 1,5-hexadiene as substrate. In this case, the products from each type of reaction are distinct and easily assayed by GC methods. Direct Hg\* chemistry gives largely [2.1.1]bicyclohexane and propenylcyclopropane by triplet sensitization<sup>19</sup> (eq 9a), while H atom addition yields hex-1-en-5-yl radicals, which give the products shown in eq 9b.

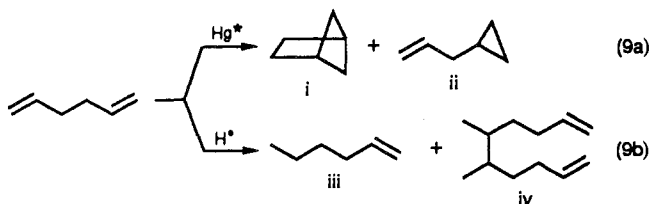

Table III gives the percentage reaction by each channel as the substrate/ $\text{H}_2$  ratio was changed by altering the temperature in the liquid phase. These results suggest that, even at a 1/1 ratio of  $\text{H}_2$  to substrate, as much as 70% of the reaction goes via the H atom channel. The net  $\text{H}_2$ /substrate ratio that we quote may not apply to the reaction zone,<sup>16,8</sup> which is only 0.1–5 mm thick (depending on the Hg vapor pressure).

$\text{H}_2$  has a smaller quenching cross section (QCS) than most other substrates (e.g.,  $^1\text{a}$   $\text{H}_2$ ,  $6 \text{ \AA}^2$ ;  $\text{C}_2\text{H}_4$ ,  $26 \text{ \AA}^2$ ; 1,5-hexadiene,  $44 \text{ \AA}^2$ ), and so at first sight, Hg\* should be dominant in eq 9; nevertheless, the opposite is observed. The reason seems to be that the  $\text{H}_2$  molecule is very light and so moves very rapidly in the vapor phase compared to Hg\* and S. This means that Hg\* is much more likely to collide with  $\text{H}_2$  than with S, even if the mole ratio 1/1. The large gas-kinetic velocity of  $\text{H}_2$  in the vapor phase therefore leads to  $\text{H}_2/\text{Hg}^*$  collisions predominating over other potentially reactive collisions. From kinetic theory, the root mean square (rms) velocity of a molecule depends on  $(\text{MW})^{-1/2}$ . Assuming the quantum yields are the same for both pathways, we expect the ratio of Hg\* to H\* products to be  $1.4n(\text{QCS}(\text{S}))/6(\text{MW}(\text{S}))^{1/2}$  (where QCS(S) and MW(S) are, respectively, the quenching cross section and molecular weights of the substrate and  $n$  is the mole ratio of substrate to  $\text{H}_2$ ). For 1,5-hexadiene, this expectation is approximately realized in practice (at 0 °C, observed 0.075, theory 0.11).

**Preventing Alkene Polymerization.** The radical formed by H atom addition to the alkene can add to a second molecule of alkene. Polymer formation is possible by this route, since the new radical retains its ability to add to monomer even in the condensed phase. This means that vapor pressure selectivity might not be effective in limiting polymer formation. Surprisingly, most alkenes still give dimer and not polymer under the conditions described here.

Some substrates, such as acrylonitrile, have an unusually high tendency to polymerize, and these were useful in learning how

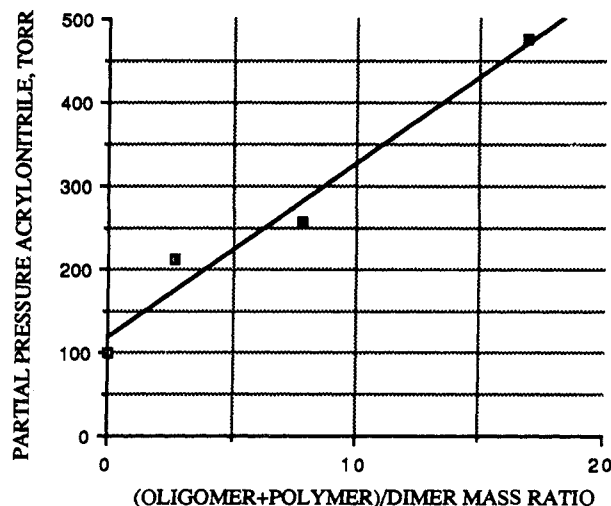

Figure 4. Partial pressure of acrylonitrile vs (oligomer + polymer)/dimer ratio.

to control polymerization. This can be done by proper choice of temperature and  $\text{H}_2$ /substrate ratio. The activation energy for  $\text{R}^* + \text{alkene}$  is clearly substantially higher than for  $\text{H}^* + \text{R}^*$ <sup>20</sup> because the polymer/dimer ratio increases rapidly with temperature. A photochemical system can be run at much lower temperatures than one that involves thermal generation of radicals. With air cooling, the normal reactor temperature is ca. 43 °C. The polymer/dimer ratio also depends on the  $\text{H}_2$ /substrate ratio, as shown in Figure 4. Experimentally, the ideal vapor pressure of acrylonitrile is ca. 100 Torr. We will see later that 100 Torr is also desirable for other substrates. It is therefore best to run the reaction so that the partial pressure of S is close to this value. Under these conditions, the  $p(\text{H}_2)/p(\text{S})$  ratio is 6.6. Recombination of H atoms with  $\text{R}^*$  does not seem to be a major pathway, probably because  $[\text{H}^*]$  is low as a result of efficient H atom scavenging by alkene.

**Rearrangement of Hot Radicals.** When the H atom adds to an alkene, the newly formed radical is "hot",<sup>20</sup> having ca. 40 kcal/mol of excess energy. We wanted to see if these radicals would undergo any reactions not open to their cold counterparts. A clear-cut example came from addition of H atoms to 3,3-dimethyl-1-butene. Table IV shows that the products include ones derived from a methyl 1,2-shift in an amount that suggests that 5% of the radicals undergo rearrangement.  $\text{CO}_2$  probably takes away some of the excess energy of the hot radicals by collisions<sup>21</sup> because its addition to the vapor phase led to a decrease in the amount of rearrangement. In contrast, the reaction of Hg\* and 2,2-dimethylbutane gives only a trace of rearrangement product, evidence that the radicals are formed from the alkane with less excess energy. No more than 25 kcal/mol of excess energy is likely to be present in this case. 1,2-Shifts of alkyl groups in radicals are not normally seen at all.<sup>22</sup>

**Other Radical Rearrangements.** Addition of hydrogen atoms to 1,6-diene systems (23) afforded the corresponding 1-ene-6-yl radicals 24 that efficiently cyclize to an isomeric mixture of dimers (eq 10). No unsaturated (uncyclized) product is detected in the mixture. 1,6-Dienes are known to form cyclopolymers by radical initiation,<sup>23</sup> in which the same five-membered rings can be identified.<sup>24</sup> In our system, the design and reaction conditions

(20) Rabinovitch, B. S.; Davis, S. G.; Winkler, C. A. *Can. J. Res.* **1943**, *B21*, 251.

(21) At higher concentrations of  $\text{CO}_2$ , a rise in the rearrangement was observed but this effect has not been studied in detail.

(22) March, J. *Advanced Organic Chemistry*, 3rd ed.; Wiley: New York, 1985; p 540.

(23) (a) Solomon, D. H.; Hawthorne, D. G. *J. Macromol. Sci., Rev. Macromol. Chem.* **1976**, *15*, 143. (b) Corfield, G. C. *Chem. Soc. Rev.* **1972**, *1*, 523.

(24) (a) Johns, S. R.; Willing, R. I.; Middleton, S.; Ong, A. K. *J. Macromol. Sci., Chem.* **1976**, *10*, 875. (b) Hawthorne, D. G.; Solomon, D. H. *Ibid.* **1976**, *10*, 923.

Table IV. Composition of the Dimer Mixture in the Reactions of *t*-BuCH=CH<sub>2</sub> and *t*-BuCH<sub>2</sub>CH<sub>3</sub>

substrate	conditions	products (%)					satd <sup>a</sup>	unsatd <sup>b</sup>
<i>t</i> -BuCH=CH <sub>2</sub>	Hg*, H <sub>2</sub>	83	8	8	1	tr		
<i>t</i> -BuCH <sub>2</sub> CH <sub>3</sub>	Hg*	81	tr	6			13	
<i>t</i> -BuCH=CH <sub>2</sub>	Hg*, H <sub>2</sub> /CO <sub>2</sub> (2:1)	78	6	12	2			2
<i>t</i> -BuCH <sub>2</sub> CH <sub>3</sub>	Hg*, CO <sub>2</sub>	76	2	5	tr		17	tr

<sup>a</sup>Saturated dimers largely from recombination of two 1° radicals. <sup>b</sup>Unsaturated products.

enable us to selectively obtain the cyclic dimers. A mixture of the corresponding cyclized monomers was also formed and may be collected in a CO<sub>2</sub>/acetone trap.

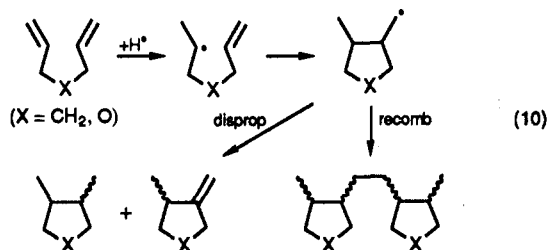

**Addition of H Atoms to Alkynes and Aromatics.** H atom addition to alkynes was studied in the 1940s.<sup>25</sup> C<sub>2</sub>H<sub>2</sub> catalyzed recombination of H atoms and ethane because "hot" C<sub>2</sub>H<sub>3</sub> tends to react with H atoms to give H<sub>2</sub> and C<sub>2</sub>H<sub>2</sub>. Some butane and unsaturated polymer were also observed. We have briefly studied heavier alkynes in hydrodimerization and find that 3-hexyne and 4-octyne gives mixtures of hydrodimers very similar to those obtained from 3-hexene and 4-octene. The major products are the saturated 3-3' and 4-4' dimers, respectively. The high quantum yields for alkyne dimerization imply that catalyzed H atom recombination is not a major pathway under our conditions; the alkyl chain may provide a thermal bath to take up the excess energy of H atom addition.

There is an interesting difference between H addition to RCH=CH<sub>2</sub> and to RC≡CH. In the first case, a relatively unreactive 2° alkyl radical is formed, but in the latter the product is a much more reactive vinyl radical. The reactivity of radicals for H abstraction is measured by the *D*(C—H) of the C—H bond formed. In the case of a 2° alkyl this is ca. 95 kcal/mol, but for a vinyl C—H the value is at least 108 kcal/mol, a reflection of the stronger sp<sup>2</sup> C—H bond in the vinyl case. Since the H—H bond strength is ca. 104 kcal/mol, we can conclude that eq 11 is endothermic for a 2° alkyl, but exothermic for a vinyl radical.

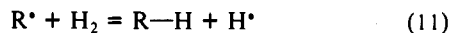

Our observations suggest that the intermediate vinyl radical does not dimerize but abstracts H from H<sub>2</sub> to give the alkene, which in turn rapidly reacts with H atoms. This explains why the products we see from an alkyne resemble those from the corresponding alkene. As expected on this picture, the low boiling point fraction in the product mixture consists mainly of the fully hydrogenated monomers (i.e., hexane and octane), together with some (ca. 3–5%) alkene.

If the preceding argument is correct, these intermediate vinyl radicals should also be capable of abstracting H from other groups, for example from a 2° position on a saturated chain. The hydrodimerization of 1-heptyne provides a notable example. H atom addition yields a mixture of cyclized and linear dimers and monomers. It is easy to tell that some of the cyclic products are identical with the ones formed in the reaction of H atoms with 1,6-heptadiene. We propose the reaction sequence shown in eq 12 by analogy with a similar scheme suggested for the addition of CCl<sub>3</sub> to 1-heptyne in solution.<sup>26</sup> H atom addition generates a vinyl radical that abstracts an H<sup>•</sup> from the 2° C—H bond in

the δ-position. The resulting 1-alken-5-yl radical gives the same products as formed in eq 10.

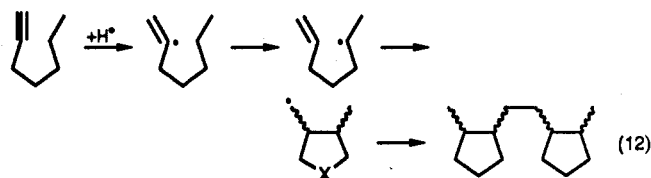

Aromatic substrates undergo Hg-photosensitized decompositions with formation of a mixture of products that includes dimers.<sup>27</sup> We wondered what the outcome would be with H atoms. Substrates of types **25** and **26** were studied. In most cases, the product consisted of a complex mixture of dimers, but extensive polymerization also took place for the styrene derivatives. Aralkyl radicals **27** derived from **25** or **26** are known to undergo R<sup>•</sup> attack at the ortho and para position of the ring to produce a coupled methylenecyclohexadiene product (eq 13).<sup>28</sup> This, as well as direct addition of H atoms to the aromatic ring to give cyclohexadienyl radicals, may be occurring. The complexity of the product mixtures was not encouraging for successful synthetic application, and the area was not pursued.

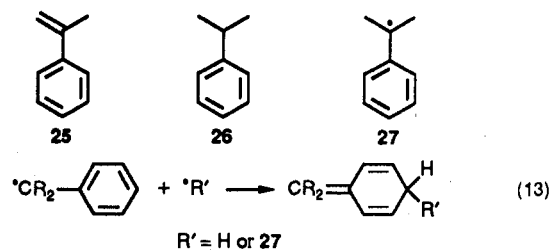

**Extension to Dehydrodimerization.** The remarkable tolerance of H atoms for the functional groups shown in Table I made us consider using the H atom as an abstractor in dehydrodimerization of functionalized substrates. This seemed to be reasonable, because the mechanism of the Hg\* system includes such a step (eq 3). In initial studies, we used substrates that also react under Hg\* conditions, e.g., unsaturated alcohols and amines, and we found that the use of H<sub>2</sub> improves the selectivity of the reaction in each case.<sup>15b</sup> This relates to our earlier work on "diluent gas" effects in Hg\* dehydrodimerization. Brown and Crabtree<sup>18</sup> found that carrying out the Hg\* reaction under H<sub>2</sub> led to improved selectivity over Hg\* or Hg\*/N<sub>2</sub> reactions. Under H<sub>2</sub>, the more selective H atoms take over from Hg\* as the main H atom abstractor in the vapor.

There are several advantages to hydrogen atom mediated dehydrodimerizations. First, hydrogen atoms are selective abstracting agents for a wider variety of substrates. Second, as in hydrodimerization, H atoms do not take part in direct reaction with substrate heteroatom lone pairs or π systems, which form exciplexes with Hg\*. Third, α,β-unsaturated ketones, esters, and acids show a strong tendency to polymerize under hydrodimerization conditions, but the reaction of their saturated counterparts avoids this complication and can be carried out very

(25) LeRoy, D. J.; Steacie, E. W. R. *J. Chem. Phys.* **1944**, *12*, 369.

(26) Heiba, E. I.; Dessau, R. H. *J. Am. Chem. Soc.* **1967**, *89*, 3772.

(27) Hikuni, M.; Takase, A.; Murano, M.; Takahasi, M. *Bull. Chem. Soc. Jpn.* **1973**, *46*, 1048.

(28) (a) Nelsen, S. F.; Bartlett, P. D. *J. Am. Chem. Soc.* **1966**, *88*, 137. (b) Skinner, K. J.; Hochster, H. S.; McBride, J. M. *ibid.* **1974**, *96*, 4301.

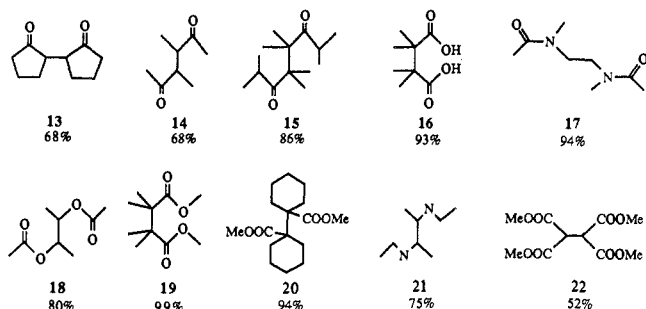

Figure 5. Some dehydrodimerization products.

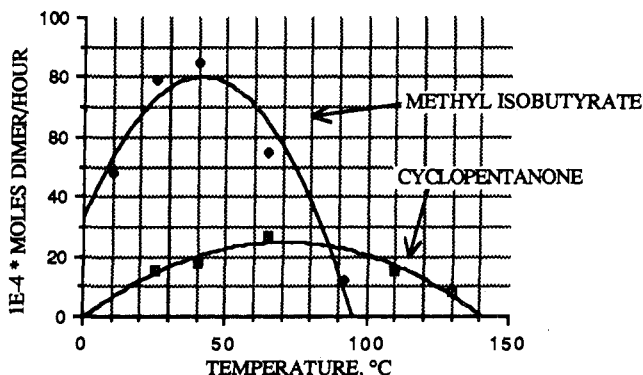

Figure 6. Rate of dimer formation vs temperature. In both cases, the vapor pressure at the optimum rate is 100 Torr.

efficiently. The weakest C—H bonds are attacked, and so the new C—C bond is formed  $\alpha$  to the functional group. This contrasts with hydrodimerization, where the position of the C=C double bond determines the site for coupling.

Nitriles, such as  $\text{CH}_3\text{CN}$  or *i*-PrCN, not only fail to dimerize under  $\text{Hg}^*$  conditions, but also dramatically reduce the rate of  $\text{Hg}^*$  reaction with a good substrate, such as cyclohexane. At a 1/1 vapor ratio of  $\text{CH}_3\text{CN}$  and cyclohexane, the rate of alkane dimerization is reduced to ca. 1% of its value in pure alkane. We ascribe this to the high QCS of nitriles, which leads to chemically nonproductive energy transfer during  $\text{Hg}^*/\text{MeCN}$  collisions. Although MeCN is still inactive under H atom conditions, *i*-PrCN can be dehydrodimerized in the presence of  $\text{H}_2$ , showing that  $\text{Hg}^*$  can attack  $\text{H}_2$  at a reasonable rate even in the presence of the CN group. On the gas-kinetic argument,  $\text{H}_2$  moves faster than RCN and can intercept and quench  $\text{Hg}^*$  before the latter is deactivated by collision with RCN. The H atoms formed in this process clearly do not add to the CN triple bond, but prefer to abstract from the (weakest)  $\alpha$ -CH bonds and form the C-centered radical. Cyclohexane, traveling slowly, does not effectively compete with the nitrile for the available  $\text{Hg}^*$  atoms; in addition, the nitrile has by far the larger QCS.

Figure 5 shows dimers obtained by H atom dehydrodimerization. Interestingly, amides undergo preferential attack at C—H bonds  $\alpha$  to N. In  $\text{EtCONMe}_2$ , attack occurs equally at the NMe and the  $\text{MeCH}_2$  position, and in  $\text{MeCONMe}_2$ , attack occurs exclusively at the NMe group. In contrast, esters are attacked preferentially  $\alpha$  to C rather than  $\alpha$  to O. In  $\text{EtCO}_2\text{Et}$ , for example, there is a 60/40 preference,<sup>15b</sup> while in *i*-PrCO<sub>2</sub>Me attack is exclusively at  $\text{Me}_2\text{CH}$ .

The same experimental protocols (presaturation and in situ) employed in hydrodimerization are used in the case of hydrogen atom assisted dehydrodimerizations. Again, high concentrations of substrate in the vapor phase lead to direct  $\text{Hg}^*$  chemistry that does not produce dimers, while too little substrate results in low conversion to dimers. Optimum conditions were found by running a series of reactions of a substrate at different temperatures. Figure 6 shows the results for methyl isobutyrate and for cyclopentanone. The optimum temperature for both substrates, and for most other substrates in general, corresponds to a substrate vapor pressure of ca. 100 Torr. If a substrate is too volatile for

Table V. Relative Reactivities of Various Types of C—H Bonds Toward H Atoms and the Bond Strengths Calculated from the Cier Equation (kcal/mol)

	rel reactivity <sup>a</sup>	calcd BDE	lit. BDE <sup>32</sup>
cyclohexane	1	95.5 <sup>b</sup>	95.5 $\pm$ 1
isopentane (3°)	15.7	92.2	93 (3°, av)
isopentane (2°)	1.1	95.4	95 (2°, av)
pentane (1°)	0.03	99.7	98 (1°, av)
pentane (2°, av)	0.89	95.6	95 (2°, av)
methanol	1.9	94.7	94.0 $\pm$ 2
methyl propionate <sup>c</sup>	2.3	94.5	
methyl isobutyrate <sup>c</sup>	9.9	92.7	
cyclopentanone <sup>c</sup>	2.7	94.3	
diisopropyl ketone <sup>c</sup>	19.5	91.9	
tetrahydrofuran	7.0	93.2	92 $\pm$ 1

<sup>a</sup> Per C—H bond. <sup>b</sup> Assumed. <sup>c</sup> Of the C—H bond  $\alpha$  to C=O.

in situ work, it is necessary to use the presaturation technique instead. For substrates with boiling points up to 100 °C, we prefer the presaturation technique, while higher boiling substrates were more conveniently run in situ.

**Cross-Dimerization.** As in our previous work, the use of mixed substrates, i.e.,  $\text{R}^1\text{—H}$  and  $\text{R}^2\text{—H}$ , leads to a mixture of the homodimers and cross-dimers in approximately statistical proportion. The product ratios determined for different substrates  $\text{R}^1\text{—H}$  and  $\text{R}^2\text{—H}$  depend on the mole ratios  $n_1$  and  $n_2$  of the two species in the vapor, the number of reactive bonds  $b_1$  and  $b_2$ , and their relative reactivities  $\rho_1$  and  $\rho_2$ . We determined the relative reactivity,  $\rho$ , for a series of substrates (Table V) on a per-bond basis with  $\rho(\text{cyclohexane})$  defined as unity. These data can be used to optimize conditions for the synthesis of particular cross-dimers. As an example, to maximize the cross-dimer between components 1 and 2, we need a vapor-phase mole ratio  $n_1/n_2$  equal to  $b_2\rho_2/b_1\rho_1$ . The  $\rho$  values in Table V lead to a ratio of 2.2 for cyclohexane and cyclopentanone, which should give a 1/2/1 molar ratio of alkane homodimer/cross-dimer/ketone homodimer and so maximize cross-dimer formation.

**Hydrogen Atoms as Reagents.** There is some disagreement in the literature about the selectivity of H atoms. Some authors have considered them as being relatively reactive and unselective; others have reported higher selectivity. The relative rates of attack on 3° vs 2° alkane C—H bonds are good measures of selectivity. Values between 30/1 and 8/1 have appeared in the literature; by comparison, the value for  $\text{Hg}^*$  is 7.5/1 in the case of 2-methylbutane. The different values found for H atoms may depend on how "hot" they were, which will depend on the synthetic route. For 2-methylbutane, we find a value of 14.7/1, close to the midpoint of the published range and large enough to give useful selectivity. Even for substrates that dimerize under direct mercury photosensitization, the addition of  $\text{H}_2$  can be used to increase selectivity; for example, with diethyl amine, the percentage of 2,2' dimer **21** in the dimer fraction increases from 40 to 75% on moving from  $\text{Hg}^*$  to H atom conditions.

The  $\text{Cl}^*$  atom is an electrophilic radical and has been shown to avoid H abstraction even of weak C—H bonds if they are  $\alpha$  to an electron-withdrawing group.<sup>29</sup> Our data confirm that the H atom is neither electrophilic nor nucleophilic. H atoms are little affected by steric factors; we see no trace of the  $(\omega - 1)$  selectivity pattern sometimes seen for abstraction by bulky or charged radicals.<sup>30</sup> This means that  $\text{H}^*$  abstracts C—H bonds with a selectivity strictly based on the C—H bond strength of the bond in question independent of polar or steric effects.

In a previous paper, we used the Cier equation (eq 14) to estimate C—H bond energies.<sup>31</sup> In eq 14,  $r_1/r_2 = N_1(c)^{1/2}/$

(29) March, J. *Advanced Organic Chemistry*, 3rd ed.; Wiley: New York, 1985; p 616.

(30) (a) Deno, N. C.; Billups, W. E.; Fishbein, R.; Pierson, C.; Whalen, R.; Wyckoff, J. C. *J. Am. Chem. Soc.* **1971**, *93*, 438. (b) Deno, N. C.; Pohl, D. G. *J. Org. Chem.* **1975**, *40*, 380. (c) Deno, N. C.; Eisenhardt, K.; Fishbein, R.; Pierson, C.; Pohl, D.; Spinelli, H.; White, R. C.; Wyckoff, J. C., *Proceedings of the 23rd Congress of Pure and Applied Chemistry*; Butterworths: London, 1974; p 155.

$N_2(a)^{1/2}$ ,  $N_n$  is the mole fraction of  $R_n-H$  in the vapor-phase mixture,  $a$  and  $c$  are the molar percentages of  $R_1-R_1$  and  $R_2-R_2$  in the dimeric products at short reaction times,  $b_n$  are the number of weakest reactive bonds in  $R_n-H$ , and  $E_n$  are the bond dissociation energies of the reactive bonds in substrate  $R_n-H$ . From

$$r_1/r_2 = (b_2/b_1) \exp[(E_1 - E_2)/2RT] \quad (14)$$

the observed product ratio of  $R_1-R_1$  and  $R_2-R_2$  in an ( $H^+ + R_1-H + R_2-H$ ) experiment at short reaction times, we can estimate the relative bond strengths involved. For  $Hg^*$  as abstractor, the method only worked well for alkanes, and deviations from ideal behavior were observed for other systems, no doubt as a result of exciplex formation. Since H atoms do not form such exciplexes, we are now able to apply this method to a wide range of compounds (Table V). When a bond dissociation energy (BDE) for cyclohexane of 95.5 kcal/mol is assumed, remarkably close agreement is seen in cases where literature data<sup>32</sup> are available and estimates are obtained for several functionalized compounds for which no data are currently available.

**Statistical vs Nonstatistical Recombination.** In a cross-dimerization, the products are normally formed in a statistical ratio. If  $f_1$  and  $f_2$  are the fraction of radicals  $R_1$  and  $R_2$  formed in the gas phase, then the fraction  $P$  of each of the possible products normally conforms closely to the statistical values given in eqs 15-17.

$$P(R^1-R^1) = (f_1)^2 \quad (15)$$

$$P(R^1-R^2) = 2f_1f_2 \quad (16)$$

$$P(R^2-R^2) = (f_2)^2 \quad (17)$$

Statistical ratios are indeed observed in the products from  $Hg^*$  and H atom reactions in nearly all cases. We will assign the values  $k_{11}$ ,  $k_{12}$ , and  $k_{22}$  for the rate constants for formation of  $R_1-R_1$ ,  $R_1-R_2$ , and  $R_2-R_2$ , respectively. As pointed out by Kerr and Trotman-Dickenson,<sup>33</sup> for a statistical distribution to be observed,  $k_{12}$  must be the rms average of  $k_{11}$  and  $k_{22}$ . In such a case, the cross-combination ratio, usually denoted  $\phi$  and defined as  $k_{12}/(k_{11}k_{22})^{1/2}$ , takes a value of 2.0. Experimentally, many  $\phi$  values are very close to 2, almost all lie in the range 0.5-4, and the "geometric mean rule", by which  $\phi = 2$ , is obeyed reasonably well in most cases.

Experimentally, allyltrimethylsilane and cyclohexene in 1/1 vapor ratio gave a 28/47/25 ratio of disilane/cross-dimer/bicyclohexyl, very close to the statistical value of 1/2/1 ( $\phi = 2$ ). This implies that H atoms add at essentially equal rates to the two types of alkene to give  $R_1$  and  $R_2$  in equal amounts and that these radicals recombine in an essentially statistical way.

**Nonstatistical Recombination from H-Bonding Effects.** A new effect was found in the case of radicals that can show hydrogen bonding. For example, mixtures of certain unsaturated alcohols and cyclohexene react with H atoms to give grossly nonstatistical product ratios in which the proportion of cross-dimers is abnormally small. Similar effects are seen for  $Hg^*/$ cyclohexane/unsaturated alcohol systems. In both cases, the effects disappear if the -OH group is replaced by -OAc. The most likely explanation of this effect is H bonding between two alcohol molecules, as shown in eq 18. When an H atom adds, the situation resembles

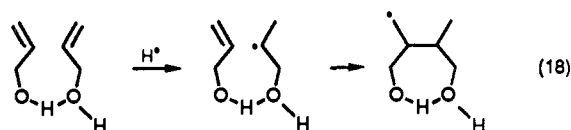

























the diene case (eq 10) and the C-C-bonded dimer can form if the ring size is favorable. H-bonding may simply serve to prolong the life of the collision complex between the hydroxyalkyl radical and the alcohol and so favor  $C^*$  addition to the C=C bond.

(31) In our original paper (ref 1g) a factor of 2 was omitted from the denominator of the equation, which should read as shown in the text.

(32) McMillen, D. F.; Golden, D. M. *Annu. Rev. Phys. Chem.* **1982**, *33*, 493.

(33) Kerr, J. A.; Trotman-Dickenson, A. F. *J. Chem. Soc.* **1960**, 1609.

Table VI. Cross-Dimerization of Unsaturated Alcohols

cosubstrates	conditions	$\beta$	$\phi$
	 $Hg^*$ , $H_2$	5.15	0.881
	 $Hg^*$	1.35	1.72
	 $Hg^*$ , $H_2$	0.873	2.14
	 $Hg^*$	0.123	5.70
	 $Hg^*$ , $H_2$	6940	0.024
	 $Hg^*$	1150	0.059
	 $Hg^*$ , $H_2$	244	0.128
	 $Hg^*$	416	0.098
	 $Hg^*$ , $H_2$	0.873	2.14
	 $Hg^*$	0.651	2.48
	 $Hg^*$ , $H_2$	7.43	0.73
	 $Hg^*$	3.57	1.06

3,3-Dimethylallyl alcohol and 3-methyl-3-buten-1-ol give the same radical on H atom addition, but the  $\beta$  value differ for the two systems. This means we are not simply dealing with an  $R^* + R^*$  recombination, but an  $R^* +$  alkene reaction as shown in eq 18.

A kinetic analysis for the  $Hg^*/$ cyclohexane/unsaturated alcohol system, which is easier to treat (see supplementary material), indicates that if the alcohol-alcohol recombination is accelerated by a factor  $\beta$ , then the new ratio of  $R_1-R_1$ ,  $R_1-R_2$ , and  $R_2-R_2$  in the products will no longer be  $f_1^2/2f_1f_2/f_2^2$ , but will change to  $f_1^2/2(\beta)^{-1/2}f_1f_2/f_2^2$ . The cross-combination factor  $\phi$  is no longer 2, but becomes  $2/\beta^{1/2}$ . No simple analysis applies for the  $H^*/$ cyclohexane/unsaturated alcohol system, which we cannot treat exactly; this probably accounts for the difference in  $\beta$  values for the same alcohols in the two systems.

The  $\beta$  and  $\phi$  values are also listed in Table VI. When the H-bonded transition state has a geometry favorable for dimerization, we find  $\beta$  values much larger than unity; if not,  $\beta$  is close to 1, e.g., 1,1-dimethylallyl alcohol and intermediate **28**. In the other two cases, the  $\beta$  values are quite large. For 3,3-dimethylallyl alcohol, the cyclic conformation **29** is suggested, where the absence of the  $Me_2C$  group helps relieve steric congestion. The intermediate  $\beta$  values for 3-methyl-3-butenol may indicate that the seven-membered ring **30** is less favorable than **29**, but not as sterically crowded as **28**. The breakdown of the geometric mean rule as a result of H bonding is much more dramatic than in any previous case we are aware of (eq 18).

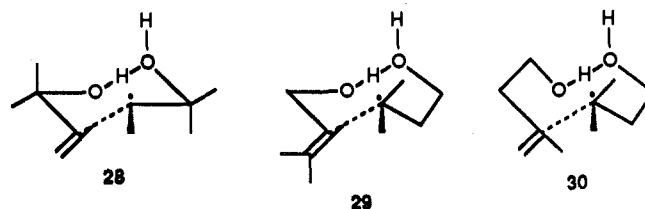

Sometimes, nonstatistical ratios can be observed but are an artifact, resulting from poor mixing in the reactor, leading to the

Table VII. Quantum Yields

substrate	quantum yield	$p_v$ (Torr)
1-hexene	0.25 <sup>a</sup>	242 <sup>b</sup>
1,5-hexadiene	0.28 <sup>a</sup>	416 <sup>b</sup>
perfluoro-1-heptene	0.13 <sup>a</sup>	210 <sup>b</sup>
5-epoxy-1-hexene	0.07 <sup>a</sup>	26 <sup>b</sup>
diallylether	0.02 <sup>a</sup>	124 <sup>b</sup>
allylalcohol	0.005 <sup>a</sup>	70 <sup>b</sup>
1,7-octadiene	0.005 <sup>a</sup>	50 <sup>b</sup>
methyl isobutyrate	0.20 <sup>c</sup>	100 <sup>d</sup>
cyclopentanone	0.064 <sup>c</sup>	72 <sup>e</sup>

<sup>a</sup> Light intensity, 11 mEinstein/h. <sup>b</sup> Temp = 43 °C. <sup>c</sup> Light intensity, 43 mEinstein/h. <sup>d</sup> Temp = 40 °C. <sup>e</sup> Temp = 65 °C.

selective depletion of one substrate in the reaction zone. To check that this is not the case for the alcohols discussed here, we also looked at reactions involving refluxing cyclohexane and unsaturated alcohol in the absence of H<sub>2</sub>. The H atoms formed from reaction of Hg\* with cyclohexane add to the unsaturated alcohol to give the alcohol radical. The refluxing cyclohexane "stirs" the gas phase, promoting good mixing. The results show that very large  $\beta$  values are observed for the same unsaturated alcohols, confirming the effect is real. In addition, the corresponding reactions of ethers and esters derived from the alcohols do not show the high values of  $\beta$ , supporting the argument of hydrogen bonding.

**Quantum Yields.** Table VII lists some values of quantum yields in hydrodimerizations and dehydrodimerization. The number of photons was determined by use of the dehydrodimerization of triethylsilane under reflux as an actinometer, sensitive to 254 nm.<sup>34</sup> The silane dimerization is a reaction with an established quantum yield.

**Choice of Method.** The same products are often available by more than one of the three methods that we have discussed here and in previous papers: (i) Hg\* and a saturated substrate,<sup>18</sup> (ii) Hg\*, H<sub>2</sub>, and an unsaturated substrate,<sup>15a</sup> (iii) Hg\*, H<sub>2</sub>, and a saturated substrate.<sup>15b</sup> Method i is usually satisfactory for alkanes and saturated alcohols, amines, silanes, and ethers but not for substrates containing functionality that quenches Hg\* without giving dimers, e.g., C=N, C=O, or C=C bonds. Method ii works well for unsaturated ketones, esters, alcohols, silanes, and fluorocarbons. Hydrodimerization is also useful in giving selective dimerization at a position that may not be favored in the reaction of the corresponding saturated substrate. It is indispensable in cases where the functionality in question is prone to decomposition under Hg\* conditions, e.g., epoxides and cyclopropyl derivatives. Method iii is useful for esters, acids, ketones, and amides where the corresponding unsaturated substrates tend to polymerize (polymerization is especially severe when the C=C double bond is conjugated with a carbonyl group). Our observations imply that if a convenient thermal source of H atoms is developed, the same chemistry would be seen without the need for mercury or light.

## Conclusions

H atoms are now available in a form suitable for synthetic applications. They are formed by Hg photosensitization at 254 nm and can be used in the hydrodimerization of unsaturated substrates and in the dehydrodimerization of saturated ones. The regioselectivity is determined by the position of the C=C double bond for alkenes, but by the position of the weakest C—H bond for saturated substrates. A wide variety of functional groups is tolerated and tens of grams of the products can be made over 24 h, with unexceptional laboratory apparatus at ambient pressure and at 0–150 °C. The products are protected by condensation, and this allows high selectivity even at high conversion. Partial pressures of 100 mm/Hg for substrate and 660 mm/Hg for H<sub>2</sub> generally give the best results.

The fast gas-kinetic speed of H<sub>2</sub> in the vapor allows Hg\*/H<sub>2</sub> reactive collisions to dominate over Hg\*/S reactive collisions. H

addition to alkynes gives reactive vinyl radicals that can abstract H from H<sub>2</sub> or from an adjacent C—H bond, in which case cyclic products are formed. Highly nonstatistical recombinations were observed in the case of cross-dimerizations involving unsaturated alcohols, which we ascribe to H bonding.

## Experimental Part

NMR spectra were determined on a Bruker 250-MHz instrument, and GC analysis was carried out on a Varian 3400 gas chromatograph (50-m capillary column; methylsilicone, 0.25-mm i.d., 0.25- $\mu$ m film thickness) with a 3100 Varian integrator. Substrates were used as received from Aldrich Co., PCR, Inc., or Kodak Corp. **Caution:** Mercury vapor is toxic and appropriate precautions must be taken. No organomercury species were detected in the products, but they are saturated with Hg, which can be removed with Zn dust.

**General Method I (In Situ).** Substrates (always in excess, starting weight or volume shown for each case) were placed in the quartz photoreactor according to Figure 2a, and a drop of Hg was added. Hydrogen was passed into the system through a long needle that dipped into the substrate. When the system was filled with hydrogen, the lamps were turned on (4 or 16 8-W low-pressure lamps, 254 nm). Temperatures were usually chosen so that the substrate vapor pressure was ca. 100 mm/Hg. For the least volatile substrates, lower pressures must be accepted.

**General Method II (Presaturation).** Substrates (always in excess, starting weight or volume shown for each case) were placed in a separate vessel as depicted in Figure 2b. A drop of Hg was added to the quartz photoreactor. Hydrogen was passed through the vessel and into the photoreactor as shown in Figure 2b. When the system was filled with hydrogen, the lamps were turned on (4 or 16 8-W low-pressure Hg lamps, 254 nm). The temperature of the substrate was usually chosen so that its vapor pressure was ca. 100 mmHg.

By either method, the crude mixture of products collects by condensation inside the quartz reaction vessel. A condenser is useful at high H<sub>2</sub> flow rates and high temperatures. Any monomer in the mixture is removed under reduced pressure. Pure compounds or mixtures of isomers can be obtained from the crude products by distillation under reduced pressure or crystallization. The extent of reaction was judged from the weight of the crude dimer fraction isolated. All mixtures were analyzed by GC.

**Details for Individual Compounds.** Products were identified by comparison with authentic samples or literature data (especially our own prior work) and confirmed by <sup>13</sup>C NMR, MS, or microanalysis. NMR data are in chloroform unless stated. The data are reported as follows: substrate (volume or weight), method (I or II), photolysis time (flow rate of H<sub>2</sub>, temperature of photolysis apparatus, temperature of substrate); dimer products (compound number, weight), percentage of isomers named in dimer mixture (by GC); <sup>13</sup>C NMR data (in CDCl<sub>3</sub>, unless otherwise noted). The 16-bulb reactor was used unless the reaction time is followed by an asterisk, in which case the 4-bulb reactor was used.

Methacrylonitrile (50 g), II, 20.75 h (50 mL min<sup>-1</sup>, 65 °C, 35 °C); tetramethyl-2,3-butanedinitrile<sup>35</sup> (1, 9.2 g), 94%; (acetone-*d*<sub>6</sub>) 22.98 (q; -CH<sub>3</sub> at C2, C3), 39.97 (s; C2, C3), 122.58 (s; C1, C4).

Isopropenyl acetate (10 mL), II, 21 h (25 mL min<sup>-1</sup>, 43 °C, 25 °C); pinacol diacetate<sup>36</sup> (2, 2.65 g), 92%; 20.00 (q; CH<sub>3</sub> at C2, C3), 21.99 (q; AcO), 84.70 (s; C2, C3), 169.37 (s; CO).

Allyl acetate (15 mL), II, 24 h (25 mL min<sup>-1</sup>, 43 °C, 25 °C); *d,l*- and *meso*-2,3-dimethyl-1,4-butanediol acetate<sup>37</sup> (3, 2.04 g), 50%; 11.43 and 13.60 (q; CH<sub>3</sub> at C2, C3), 20.15 (q; AcO), 32.98 and 34.18 (d; C2, C3), 66.44 and 66.77 (t; C1, C4), 170.17 (s; CO).

Methyl acrylate (11 mL), II, 12 h\* (30 mL min<sup>-1</sup>, 25 °C, 20 °C); *d,l*- and *meso*-2,3-dimethylsuccinic acid dimethyl ester<sup>38</sup> (4, 1.22 g), 82%; 13.10 and 14.37 (q; CH<sub>3</sub> at C2, C3), 41.24 and 42.15 (d; C2, C3), 51.24 (q; OCH<sub>3</sub>), 174.49 (s, CO). Methyl propionate (5 mL), II, 12 h (20 mL min<sup>-1</sup>, 43 °C, 25 °C); 4 (0.86 g), 90%.

5-Hexen-2-one (25 g), I, 17.5 h (15 mL min<sup>-1</sup>, 65 °C); 5,6-dimethyl-2,9-decanedione (5, 6.72 g), 82%; 208.39 (s, C2, C9), 41.33 (t; C3, C8), 36.50 (d; C5, C6), 35.69 (d; C5, C6), 29.28 (q; C1, C10), 28.09 (t; C4, C7), 26.22 (t; C4, C7), 15.61 (q; CH<sub>3</sub> on C5, C6), 13.63 (q; CH<sub>3</sub> on C5, C6). MS showed expected fragmentation pattern. Elemental analysis: found 72.50 C, 10.94 H; Calcd 72.68 C, 11.18 H.

Mesityl oxide (10 mL), II, 10 h (30 mL min<sup>-1</sup>, 43 °C, 25 °C); 4,4,5,5-tetramethyloctane-2,7-dione<sup>39</sup> (6, 1.97 g), 55%; 21.04 (q; CH<sub>3</sub> at

(35) Back, R.; Sivertz, C. *Can. J. Chem.* **1954**, *32*, 1061.

(36) Detilleux, E.; Jadot, J. *Bull. Soc. Roy. Sci. Liege* **1960**, *29*, 208.

(37) Razuvaev, G. A.; Bogulavskaya, L. S. *Zh. Obshch. Khim.* **1962**, *32*, 2320.

(38) McSasland, G. E.; Proskow, S. *J. Am. Chem. Soc.* **1956**, *78*, 5646.

(34) Nay, A. W.; Woodall, G.; Gunning, H. E.; Strausz, O. P. *J. Am. Chem. Soc.* **1965**, *87*, 179.



C4, C5), 32.60 (q; C1, C8), 38.95 (s; C4, C5), 48.59 (t; C3, C6), 208.66 (s; C2, C7).

5-Epoxy-1-hexene (20 mL), 11, 39 h (30 mL min<sup>-1</sup>, 43 °C, 25 °C); stereoisomers of 5,6-dimethyldeca-1,9-diene diepoxide (7, 4.81 g, 80%; 13.63 and 15.63 (q; CH<sub>3</sub> at C5, C6), 28.36 and 28.57 (t; C4, C7), 30.02, 30.17, 30.27, and 30.36 (t; C3, C8), 35.86, 36.75, and 36.83 (d; C5, C6), 46.09, 46.18, and 46.24 (t; C1, C10), 51.60, 51.71, and 51.77 (d; C2, C9).

Allyltrimethylsilane (15 mL), 11, 38 h (30 mL min<sup>-1</sup>, 43 °C, 25 °C); *d,l*- and *meso*-2,3-dimethyl-1,4-bis(trimethylsilyl)butane<sup>40</sup> (8, 5.26 g), 84%; -0.57 and -0.51 (q; SiMe<sub>3</sub>), 17.84 and 18.97 (q; CH<sub>3</sub>), 20.50 and 22.21 (t; C1, C4), 36.51 and 36.66 (d, C2, C3).

Acrylonitrile (50 g), 11, 12 h (33 mL min<sup>-1</sup>, 65 °C, 51 °C, H<sub>2</sub> to substrate ratio 6.7, {measured}); 2,3-dimethyl-2,3-butanedinitrile<sup>41</sup> (9, 4.9 g), 99%; polymer absent (acetone-d<sub>6</sub>): 119.68 (s; C1, C4), 119.38 (s; C1, C4), 29.15 (d; C2, C3), 28.47 (d; C2, C3), 15.39 and 14.30 (q; CH<sub>3</sub>).

5-Penten-1-ol (5 mL), 1, 18 h (15 mL min<sup>-1</sup>, 50 °C, 65 °C); *d,l*- and *meso*-4,5-dimethyloctane-1,8-diol (10, 1.00 g), 68%; 14.04 and 16.01 (q; CH<sub>3</sub>), 28.54, 30.36, 30.42, and 30.54 (t; C2, C3, C6, C7), 36.18 and 36.98 (d; C4, C5), 62.28 (t; C1, C8).

3-Methyl-3-buten-1-ol (15 mL), 11, 22 h (30 mL min<sup>-1</sup>, 43 °C, 70 °C); 3,3,4,4-tetramethylhexane-1,6-diol (11, 3.07 g), 77%; 21.22 (q; CH<sub>3</sub> at C3), 37.33 (s; C3, C4), 38.77 (t; C2, C5), 59.79 (t; C1, C6).

Perfluoro-1-heptene (15 mL), 11, 25 h (30 mL min<sup>-1</sup>, 43 °C, 25 °C); 6,7-bis(difluoromethyl)perfluorododecane (12, 5.70 g), 55%; <sup>1</sup>H NMR (in acetone-d<sub>6</sub>) 6.30 d; <sup>1</sup>J(H,F) = 51.5 Hz, <sup>2</sup>J(H,F) = 4.5 Hz, CF<sub>2</sub>H—CFR<sub>2</sub>R<sub>2</sub>.

Cyclopentanone (50 g), 1, 11 h (15 mL min<sup>-1</sup>, 65 °C); *d,l*- and *meso*-2,2'-biscyclopentanone<sup>42</sup> (13, 5.03 g), 68%; 219.00 and 218.01 (s; C1, C1'), 48.53 and 47.84 (d; C2, C2'), 37.54 and 37.31 (t; C5, C5'), 26.17 and 24.88 (t; C3, C3'), 20.30 and 20.07 (t; C4, C4').

2-Butanone, (50 g), 11, 18.5 h, (20 mL min<sup>-1</sup>, 45 °C, 30 °C); 3,4-dimethyl-2,5-hexanedione<sup>43</sup> (14, 2.65 g), 68%; 13.15 and 14.27 (q; CH<sub>3</sub> at C3, C4), 28.11 and 28.72 (q C1, C6), 47.99 and 48.33 (d; C3, C4), 212.45 (s; C2, C5).

2,4-Dimethyl 3-pentanone (50 g), 1, 16 h\* (25 mL min<sup>-1</sup>, 25 °C, 25 °C); 2,4,4,5,5,7-hexamethyl-3,6-octanedione<sup>44</sup> (15, 0.95 g), 86%; 219.07 (s; C3, C6), 53.03 (s; C4, C5), 35.33 (d; C2, C7), 21.98 (q), 19.84 (q).

Isobutyric acid (12 mL), 1, 15 h (45 mL min<sup>-1</sup>, 55 °C, 75 °C), 2,2,3,3-tetramethylsuccinic acid<sup>45</sup> (16, 3.05 g), 93%; (acetone-d<sub>6</sub>) 22.27 (q; CH<sub>3</sub>), 47.03 (s; C2, C3), 178.27 (s; C1, C4).

*N,N*-Dimethylacetamide (30 g), 1, 14 h (10–15 mL min<sup>-1</sup>, 55 °C, 55 °C); 1,2-ethanediybis(*N*-methylethanamide)<sup>46</sup> (17, 2.56 g), 94%; 169.25 (C=O), 168.87 (C=O), 46.33, 46.50, 44.90, 43.14, 35.97, 35.03, 31.90, 20.34, 19.49.

Ethyl acetate (5.3 mL), 11, 20 h (30 mL min<sup>-1</sup>, 43 °C, 25 °C); *d,l*- and *meso*-2,3-butanediol diacetate<sup>47</sup> (18, 1.8 g), 80%; 14.51 and 15.45 (q; C1, C4), 20.45 and 20.51 (q; CH<sub>3</sub>CO), 70.80 and 70.93 (d; C2, C3), 169.83 and 169.92 (s; CH<sub>3</sub>CO). Vinyl acetate (8 mL), 11, 20 h\* (30 mL min<sup>-1</sup>, 25 °C, 20 °C), 18 (0.91 g), 72%.

Methyl isobutyrate (75 g), 1, 16.25 h (15 mL min<sup>-1</sup>, 40 °C, 40 °C); 2,2,3,3-tetramethylsuccinic acid dimethyl ester<sup>48</sup> (19, 28.40 g), 99%; 21.81 (d; CH<sub>3</sub> at C2, C3), 47.45 (s; C2, C3), 51.54 (q; OCH<sub>3</sub>), 176.40 (s; C1, C4).

Methyl cyclohexanecarboxylate (10 mL), 1, 18 h (45 mL min<sup>-1</sup>, 55 °C, 75 °C); [1,1'-bicyclohexyl]-1,1'-dicarboxylic acid dimethyl ester<sup>49</sup> (20, 2.31 g), 94%; 24.16 (t; C4, C4'), 25.51 (t; C3, C3', C5, C5'), 29.48 (t; C2, C2', C6, C6'), 51.27 (q; CH<sub>3</sub>), 53.98 (s; C1, C1'), 175.91 (s; CO).

Diethylamine (50 g), 11, 18 h\* (25 mL min<sup>-1</sup>, 25 °C, 0 °C); *N,N*-diethyl-2,3-butanediamine<sup>50</sup> (21, 0.75 g), 75%; (acetone-d<sub>6</sub>) 14.92, 15.05, 15.25, 15.94 (q), 41.01, 41.36 (t; RHNCH<sub>2</sub>-), 55.56, 57.45 (d, C2, C3).

Dimethyl malonate (9 mL), 1, 12 h (45 mL min<sup>-1</sup>, 55 °C, 75 °C); ethane-1,1,2,2-tetracarboxylate tetramethyl ester<sup>51</sup> (22, 0.51 g), 52%;

38.71 (d; C1, C2), 51.02 (q; CH<sub>3</sub>), 167.69 (s; CO).

**Figure 4.** Experimental details are the same as that for compound 9, but with variation in the temperature of the substrate.

**Figure 6.** Experimental details are the same as for compounds 13 and 19, but with variation in temperature of substrate.

**Table I.** The alkenes were run by method 11 in the 16-lamp photoreactor (43 °C) for 18 h. The products were identified by comparison (GC traces and <sup>13</sup>C NMR spectra) with those from reactions of the corresponding alkanes reported previously.<sup>18</sup> Details are reported as follows: alkene (volume); flow rate of H<sub>2</sub>, temperature of substrate; mixture of dimers (weight). 1-Pentene (15 mL); 15 mL min<sup>-1</sup>, 5 °C; C<sub>10</sub> dimers (4.87 g). 1-Hexene (25 mL); 30 mL min<sup>-1</sup>, 25 °C, C<sub>12</sub> dimers (8.65 g). 1-Octene (25 mL); 30 mL min<sup>-1</sup>, 65 °C; C<sub>16</sub> dimers (6.16 g).

**Table II.** The hexenes were run in the 16-lamp photoreactor (43 °C), and the products were identified as above. The 30-min reactions were run by method 1, while a very low flow of H<sub>2</sub> (ca. 3 mL min<sup>-1</sup>) was maintained after initial purge of the quartz vessel with H<sub>2</sub> (substrate, 3.7 g). The 18-h reactions were run under the conditions described for 1-hexene in the previous paragraph. The presence of unsaturated compounds in the mixture of dimers was verified by comparison of GC traces before and after hydrogenation with Pd/C-NaH<sub>2</sub>PO<sub>2</sub>.<sup>52</sup>

**Table III.** The reactions of 1,5-hexadiene (C<sub>6</sub>H<sub>10</sub>) were carried out in the 16-lamp photoreactor for 15 min. The liquid phase in the quartz vessel (1.5 L) was kept at 43 °C (*p*<sub>v</sub>[C<sub>6</sub>H<sub>10</sub>] = 418 mmHg) or 30 °C (*p*<sub>v</sub>[C<sub>6</sub>H<sub>10</sub>] = 244 mmHg) by a water bath, at 0 °C with an ice bath (*p*<sub>v</sub>[C<sub>6</sub>H<sub>10</sub>] = 68 mmHg), or at -18 °C with an ice/salt bath (*p*<sub>v</sub>[C<sub>6</sub>H<sub>10</sub>] = 22 mmHg). In each case, the system was closed after purging with H<sub>2</sub> but prior to injection of the substrate (2.5 g).

**Table IV.** The liquid substrate (3,3-dimethyl-1-butene, 2.81 g; or 2,2-dimethylbutane, 2.87 g) and the listed gases were irradiated in the 4-lamp photoreactor (25 °C) for 15 min. The quartz vessel (1.5 L) was purged with the corresponding gas (H<sub>2</sub> or CO<sub>2</sub>) or mixture of gases (H<sub>2</sub>/CO<sub>2</sub>(2/1), v/v) before injection of the substrate. The system was kept closed during photolysis. The products were identified by comparison of GC and <sup>13</sup>C NMR data available from previous study of the reactions of the alkanes 2,2- and 2,3-dimethylbutane.<sup>18</sup> We checked for the presence of unsaturated products by hydrogenation as described previously.

**Table V.** Pairs of substrates were cross-dimerized by method I at 30–45 °C to low conversion for <2 h in a 4- or 16-lamp reactor. The vapor pressure ratio was calculated from Raoult's law. Products were identified and quantified by capillary GC. The Cier equation (see text) was employed to obtain BDEs.

**Cyclization of 1,6-Dienes.** Method 11, 16-lamp photoreactor (43 °C), irradiation for 12 h. The data (organic substrate (weight); flow of H<sub>2</sub>, temperature of substrate; total weight of dimer mixture, percentage of major dimer) follow. 1,6-Heptadiene (5 g); 35 mL min<sup>-1</sup>, 25 °C; dimer, 2.78 g; 31% 1,2-bis(2-methylcyclopentyl)ethane. Diallyl ether (8 g); 20 mL min<sup>-1</sup>, 45 °C; dimer, 3.12 g; 40% 1,2-bis(3-methyl-4-tetrahydrofuranylethyl)ethane.

**Alkynes.** Method 11, 16-lamp photoreactor (43 °C). The data (organic substrate (volume), irradiation time; flow of H<sub>2</sub>, temperature of substrate; total weight of dimer mixture, percentage of major dimer) follow. 3-Hexyne (5 mL), 5 h; 20 mL min<sup>-1</sup>, 25 °C; 1.45 g, 24% 5,6-dimethyldecane. 4-Octyne (4 mL), 5 h; 30 mL min<sup>-1</sup>, 60 °C; 0.96 g, 17% 5,6-dimethyltetradecane. 1-Heptyne (6 mL), 4 h; 40 mL min<sup>-1</sup>, 35 °C; 1.34 g, 23% 1,2-bis(2-methylcyclopentyl)ethane.

**Cross-Dimers with Unsaturated Alcohols and Derivatives.** The corresponding cross-dimers and alcohol dimers were first prepared by running alcohol/cyclohexane mixtures (10 g each) by method II (30 h, 43 °C, 35 mL min<sup>-1</sup> H<sub>2</sub>), followed by separation by column chromatography (Al<sub>2</sub>O<sub>3</sub>, 20 cm × 2 cm, methanol/cyclohexane) and identification by GC. The typical alcohol-cyclohexane or alcohol-cyclohexene reactions, carried out to determine the dimer composition and β values for Table VI, are described in the following text for 3,3-dimethyl alcohol. In every case, the composition of the liquid phase was arranged to be such that the mixtures of substrates in the vapor correspond to a 1/9 ratio of alcohol/hydrocarbon (Raoult's law).

3,3-Dimethylallyl alcohol (3.22 g) and cyclohexene (1.46 g) were injected in the 1.5-L quartz vessel, previously purged with H<sub>2</sub>, and reacted (closed system) for 15 min at 43 °C in the 16-lamp photoreactor. The quartz vessel was cooled to 0 °C to allow condensation of all the material, which was then analyzed by GC.

3,3-Dimethylallyl alcohol (2.20 g) and cyclohexane (19.45 g) were brought to reflux in the 1.5-L quartz vessel (reflux condenser attached) and irradiated then for 15 min in the 16-lamp reactor. After being cooled

(39) (a) Kossanyi, J.; Kom-Mogto, J. *Org. Mass Spectrom.* **1970**, *3*, 721. (b) Wiemann, J.; Bouguerra, M. L. *Ann. Chim. (Paris)* **1967**, *2*, 35.

(40) Petrov, A. D.; Mironov, V. F. *Izv. Nauk. SSSR, Otd. Khim. Nauk.* **1952**, 535.

(41) Beech, W.; Piggott, H. *J. Chem. Soc.* **1955**, Part I, 423.

(42) Hawkins, E. G. E.; Large, R. *J. Chem. Soc., Perkin Trans. 1*, **1974**, 2, 280.

(43) Chkir, M.; Lelandais, D. *Can. J. Chem.* **1981**, *59*(6), 945.

(44) Chkir, M.; Lelandais, D. *Tetrahedron Lett.* **1974**, *36*, 3114.

(45) Fichter, F.; Heer, J. *Helv. Chim. Acta* **1935**, *18*, 1276.

(46) Made independently by acylation of *N,N*-dimethyl-1,2-ethane diamine.

(47) Bothner-By, A. A.; Naar-Colin, C. *J. Am. Chem. Soc.* **1962**, *84*, 743.

(48) Bogulavskaya, L. S. *Zh. Obshch. Khim.* **1961**, *31*, 3440.

(49) Kitabatake, M.; Ogawa, M. *Nippon Kagaku Zasshi* **1964**, *85*, 450.

(50) Ghirardelli, R.; Lucas, H. *J. Am. Chem. Soc.* **1957**, *79*, 734.

(51) Brettell, R.; Seddon, D. *J. Chem. Soc., C* **1970**, 1153.

(52) Boyer, S. K.; Bach, J. McKenna, J.; Jagdmann, E., Jr. *J. Org. Chem.* **1985**, *50*, 3408.

to allow condensation of all the material, the mixture was analyzed by GC.

**Acknowledgment.** We thank the Department of Energy for funding and Professors M. Johnson and J. M. McBride (Yale)

for helpful suggestions.

**Supplementary Material Available:** Kinetic analysis of the cross-dimerizations (1 page). Ordering information is given on any current masthead page.

## Hydrocarbon and Phosphate Triester Formation during Homolytic Hydrolysis of Organophosphonium Ions: An Alternate Model for Organophosphonate Biodegradation

L. Z. Avila, P. A. Bishop, and J. W. Frost\*

Contribution from the Department of Chemistry, Purdue University, West Lafayette, Indiana 47907. Received May 9, 1990

**Abstract:** Treatment of organotrineopentoxyposphonium trifluoromethanesulfonates with base and organic peroxides results in carbon to phosphorus (C-P) bond cleavage. The products of the homolytic hydrolysis are hydrocarbons and trineopentyl phosphate. Reaction of the organophosphonium ions with only base leads to oxygen to phosphorus (O-P) bond cleavage with a complete absence of C-P bond cleavage. The likely intermediacy of a pentacovalent phosphonyl radical during the homolytic hydrolysis provides the basis for an alternate mechanistic formulation for the C-P bond cleavage observed during organophosphonate biodegradation. This formulation is unique in its prediction of inorganic phosphate as the immediate phosphorus-containing product of microbe-mediated C-P bond cleavage.

Microbial degradation of organophosphonates **1a** (Scheme I) involving cleavage of carbon to phosphorus (C-P) bonds provides a unique challenge to chemical modeling due to the apparent exploitation of chemistry that lacks direct literature precedent. All inorganic phosphate **5a** necessary for survival is derived by the microbe from the organophosphonate **1a** phosphorus. The remainder of the organophosphonate is not utilized by the microbe as in the case of alkylphosphonate **1a** biodegradation, where (Scheme I) alkanes **3** and small amounts of alkenes **4** are generated. Although various chemical mechanisms<sup>1</sup> have been formulated that can account for alkane and alkene formation during organophosphonate biodegradation, one type of mechanistic formulation has been overlooked prior to this report.

Hydrolysis of phosphonium ions<sup>2</sup> and phosphorus ylides<sup>3</sup> has long been precedented to result in C-P bond cleavage with, in certain cases, generation of alkanes and alkenes. Likewise, hydrolysis of organophosphonate C-P bonds catalyzed by microbes

Scheme I

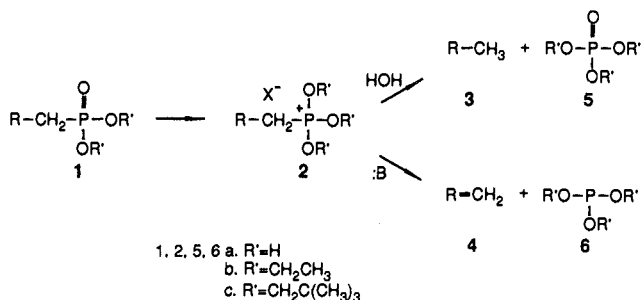

might involve initial activation of the organophosphonate as an organophosphonium ion **2a** (Scheme I). Alkanes would then be the dominant product of alkylphosphonate biodegradation. The trace levels of alkene formation might arise from a small amount of competing  $\beta$ -eliminative fragmentation of the organophosphonium ion.

Unfortunately, the relevance of organophosphonium ion and phosphorus ylide hydrolysis to microbial cleavage of organophosphonate C-P bonds is rather indirect. Hydrolyses of organophosphonium ions<sup>4</sup> structurally similar to those that could be generated during microbial degradation of organophosphonates have not been examined. This investigation thus began with the preparation and characterization of biologically relevant models in the form of organotrialkoxyphosphonium ions (**2b**, **2c**). Hydrolysis of these organophosphonium ions under appropriate conditions has been discovered to result in facile C-P bond cleavage.

### Results and Discussion

**Preparation of the Organophosphonium Models.** Organophosphonium ions that most closely resemble the putative reactive intermediate formed during microbial degradation of organophosphonates are found as reactive intermediates during Arbuzov

(1) (a) Cordeiro, M. L.; Pompliano, D. L.; Frost, J. W. *J. Am. Chem. Soc.* **1986**, *108*, 332. (b) Shames, S. L.; Wackett, L. P.; LaBarge, M. S.; Kuczkowski, R. L.; Walsh, C. T. *Bioorg. Chem.* **1987**, *15*, 366. (c) Frost, J. W.; Loo, S.; Cordeiro, M. L.; Li, D. *J. Am. Chem. Soc.* **1987**, *109*, 2166. (d) Avila, L. Z.; Frost, J. W. *J. Am. Chem. Soc.* **1988**, *110*, 7904. (e) Avila, L. Z.; Frost, J. W. *J. Am. Chem. Soc.* **1989**, *111*, 8969.

(2) (a) Fenton, G. W.; Ingold, C. K. *J. Chem. Soc.* **1929**, 2342. (b) Hey, L.; Ingold, C. K. *J. Chem. Soc.* **1933**, 531. (c) Kumli, K. F.; McEwen, W. E.; VanderWerf, C. A. *J. Am. Chem. Soc.* **1959**, *81*, 3805. (d) Zanger, M.; VanderWerf, C. A.; McEwen, W. E. *J. Am. Chem. Soc.* **1959**, *81*, 3806. (e) Hoffmann, H. *Liebigs Ann. Chem.* **1960**, *634*, 1. (f) Aksnes, G.; Songstad, J. *Acta Chem. Scand.* **1962**, *16*, 1426. (g) Hudson, R. F.; Green, M. *Angew. Chem. Int. Ed. Engl.* **1963**, *2*, 11. (h) Aksnes, G.; Brudvik, L. *J. Acta Chem. Scand.* **1963**, *17*, 1616. (i) McEwen, W. E.; Kumli, K. F.; Blade-Font, A.; Zanger, M.; VanderWerf, C. A. *J. Am. Chem. Soc.* **1964**, *86*, 2378. (j) Aksnes, G.; Brudvik, L. *J. Acta Chem. Scand.* **1967**, *21*, 745. (k) Luckenbach, R. *Phosphorus* **1972**, *1*, 223. (l) Aksnes, G. *Phosphorus Sulfur Relat. Elem.* **1977**, *3*, 227.

(3) (a) Coffman, D. D.; Marvel, C. S. *J. Am. Chem. Soc.* **1929**, *51*, 3496. (b) Schöllkopf, U. *Angew. Chem.* **1959**, *71*, 260. (c) Bestmann, H. J.; Häberlein, H.; Pils, I. *Tetrahedron* **1964**, *20*, 2079. (d) Bestmann, H. J. *Angew. Chem., Int. Ed. Engl.* **1965**, *4*, 583. (e) Seyferth, D.; Singh, G. *J. Am. Chem. Soc.* **1965**, *87*, 4156. (f) Issleib, K.; Lindner, R. *Liebigs Ann. Chem.* **1966**, *699*, 40. (g) Seebach, D. *Chem. Ber* **1972**, *105*, 487. (h) Schnell, A.; Tebby, J. C. *J. Chem. Soc., Chem. Commun.* **1975**, 134. (i) Schnell, A.; Dawber, J. G.; Tebby, J. C. *J. Chem. Soc., Perkin Trans. 2* **1976**, 633. (j) Schnell, A.; Tebby, J. C. *J. Chem. Soc., Perkin Trans. 1* **1977**, 1883.

(4) (a) Colle, K. S.; Lewis, E. S. *J. Org. Chem.* **1978**, *43*, 571. (b) Hudson, H. R.; Rees, R. G.; Weekes, J. E. *J. Chem. Soc., Chem. Commun.* **1971**, 1297. (c) Landauer, S. R.; Rydon, H. N. *J. Chem. Soc.* **1953**, 2224.